

N3100B-0058	N Plug Crimp	50Ω
-------------	--------------	-----

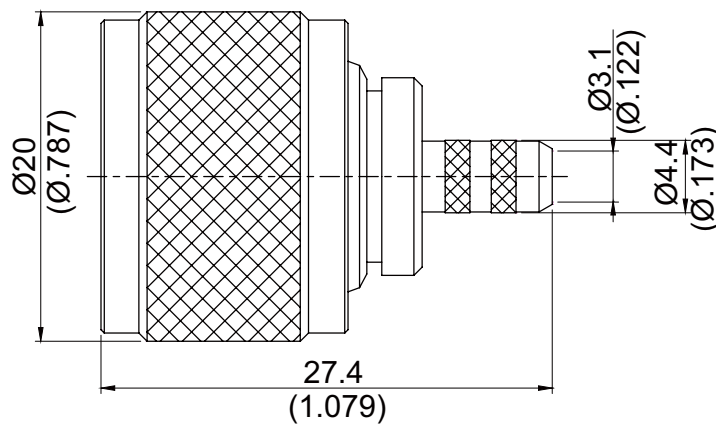

Parts	Material	Plating (Micro-inch)
Ferrule	Copper	Tin-Zinc-Copper-Alloy 100 Over Copper 50
Gasket	Silicon	
Contact Pin	Brass	Gold 4 Over Nickel Phosphorous Alloy 80 Over Copper 20
Insulator	Teflon	
Body	Brass	Tin-Zinc-Copper-Alloy 100 Over Copper 50
Coupling Nut	Brass	Tin-Zinc-Copper-Alloy 100 Over Copper 50



Weight:  
Suitable Cables:RG58,JBY195,JBY195-LSFH

**This part number complies with RoHS.**

**Notice: JYEBAO reserves the right to make modifications deemed appropriate.**

# JYE BAO CO., LTD.

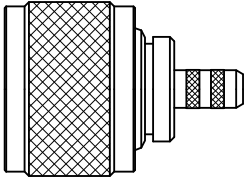
## CABLE ASSEMBLY INSTRUCTION

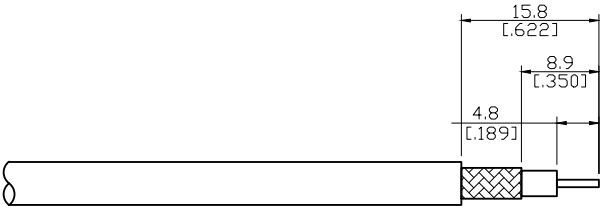
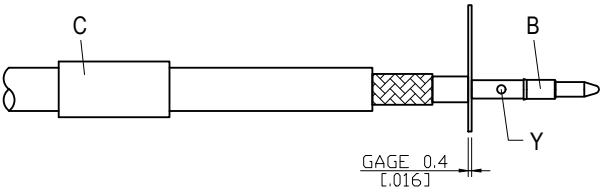
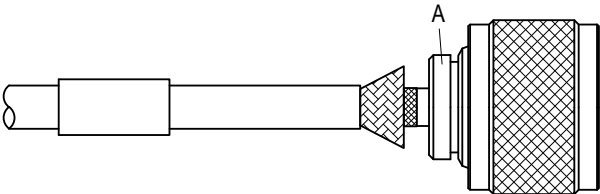
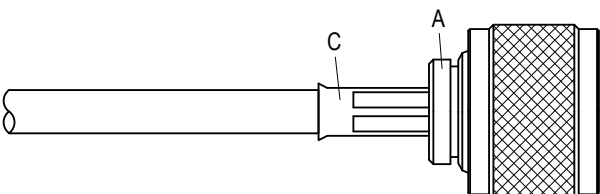
N3100B-0058	DATE	2018/02/13	REV	A
A	B	C		
				
BODY	CONTACT PIN	FERRULE		
DIAGRAM	ASSEMBLY INSTRUCTION			
	<p>Step 1: STRIP AS SHOWN.</p>			
	<p>Step 2: SLIDE FERRULE " C " OVER CABLE.            Step 3: PUT 0.4 MM GAGE IN PLACE, INSERT CABLE'S CENTER CONDUCTOR INTO CENTER PIN " B " AND SOLDER OR CRIMP IN " Y ".            (USE SQUARE 1.6mm/0.063inch SECTION OF INSERT-B IF CRIMPED)</p>			
	<p>Step 4: LOOSEN BRAIDING AND SLIDE CONNECTOR " A " IN PLACE.</p>			
	<p>Step 5: SLIDE FERRULE " C " TOWARDS THE CONNECTOR " A " AND CRIMP.            (USE 5.5mm/0.217inch HEX SECTION OF INSERT-B)</p>			

This part number complies with RoHS.

Notice: JYEBAO reserves the right to make modifications deemed appropriate.

APPROVED

CHECKED

DRAWING